

# E-001 Main Control Circuit

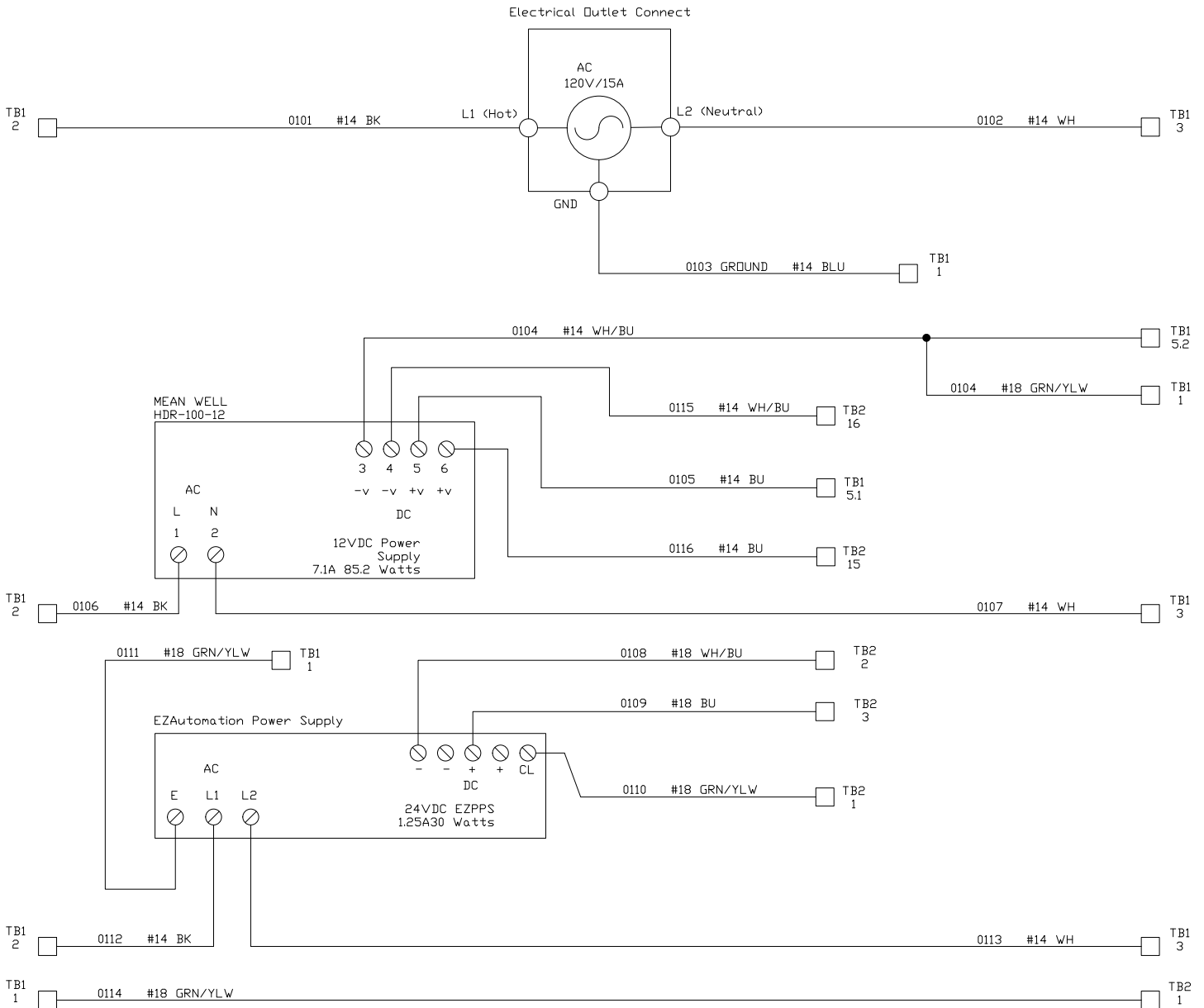

**Notes:** V1.6 adds GND cable #0114

V1.7 adds cable #0115 & #0116

**TITLE:** Power Supplies, PLC Input Card

**Drawn By:** Kurt J. Foster

See "MIT Licence"

**Project Code:** PR-01

**REV:** 1.7

**Date:** May 7, 2023

SCHEMATIC IS PROVIDED AS IS, WITHOUT WARRANTY OF ANY KIND, EXPRESS OR IMPLIED, INCLUDING BUT NOT LIMITED TO THE WARRANTIES OF MERCHANTABILITY, FITNESS FOR A PARTICULAR PURPOSE AND NONINFRINGEMENT. IN NO EVENT SHALL THE AUTHORS OR COPYRIGHT HOLDERS BE LIABLE FOR ANY CLAIM, DAMAGES OR OTHER LIABILITY, WHETHER IN AN ACTION OF CONTRACT, TORT OR OTHERWISE, ARISING FROM, OUT OF OR IN CONNECTION WITH THE SCHEMATIC OR THE USE OR OTHER DEALINGS IN THE SCHEMATIC.



**Sheet:** 1

# E-002 PLC Inputs Card

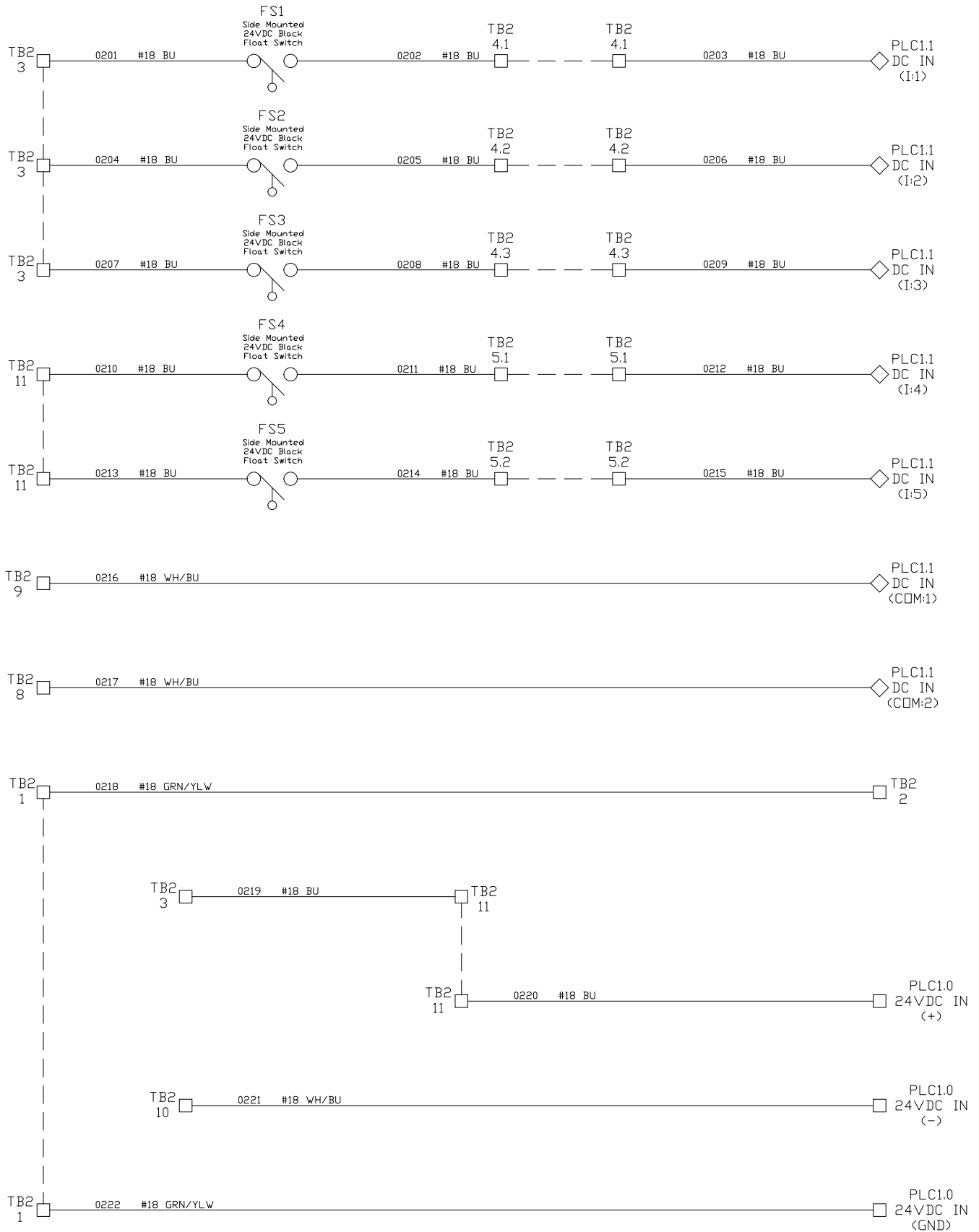

## Notes:

V1.5 adds cables #0220 to #0222

**TITLE:** Power Supplies, PLC Input Card

**Drawn By:** Kurt J. Foster

See "MIT Licence"

**Project Code:** PR-01

**REV:** 1.5

**Date:** May 7, 2023

SCHEMATIC IS PROVIDED AS IS, WITHOUT WARRANTY OF ANY KIND, EXPRESS OR IMPLIED, INCLUDING BUT NOT LIMITED TO THE WARRANTIES OF MERCHANTABILITY, FITNESS FOR A PARTICULAR PURPOSE AND NONINFRINGEMENT. IN NO EVENT SHALL THE AUTHORS OR COPYRIGHT HOLDERS BE LIABLE FOR ANY CLAIM, DAMAGES OR OTHER LIABILITY, WHETHER IN AN ACTION OF CONTRACT, TORT OR OTHERWISE, ARISING FROM, OUT OF OR IN CONNECTION WITH THE SCHEMATIC OR THE USE OR OTHER DEALINGS IN THE SCHEMATIC.

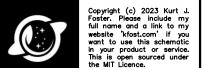

Sheet: 2

# E-003 PLC Outputs Card

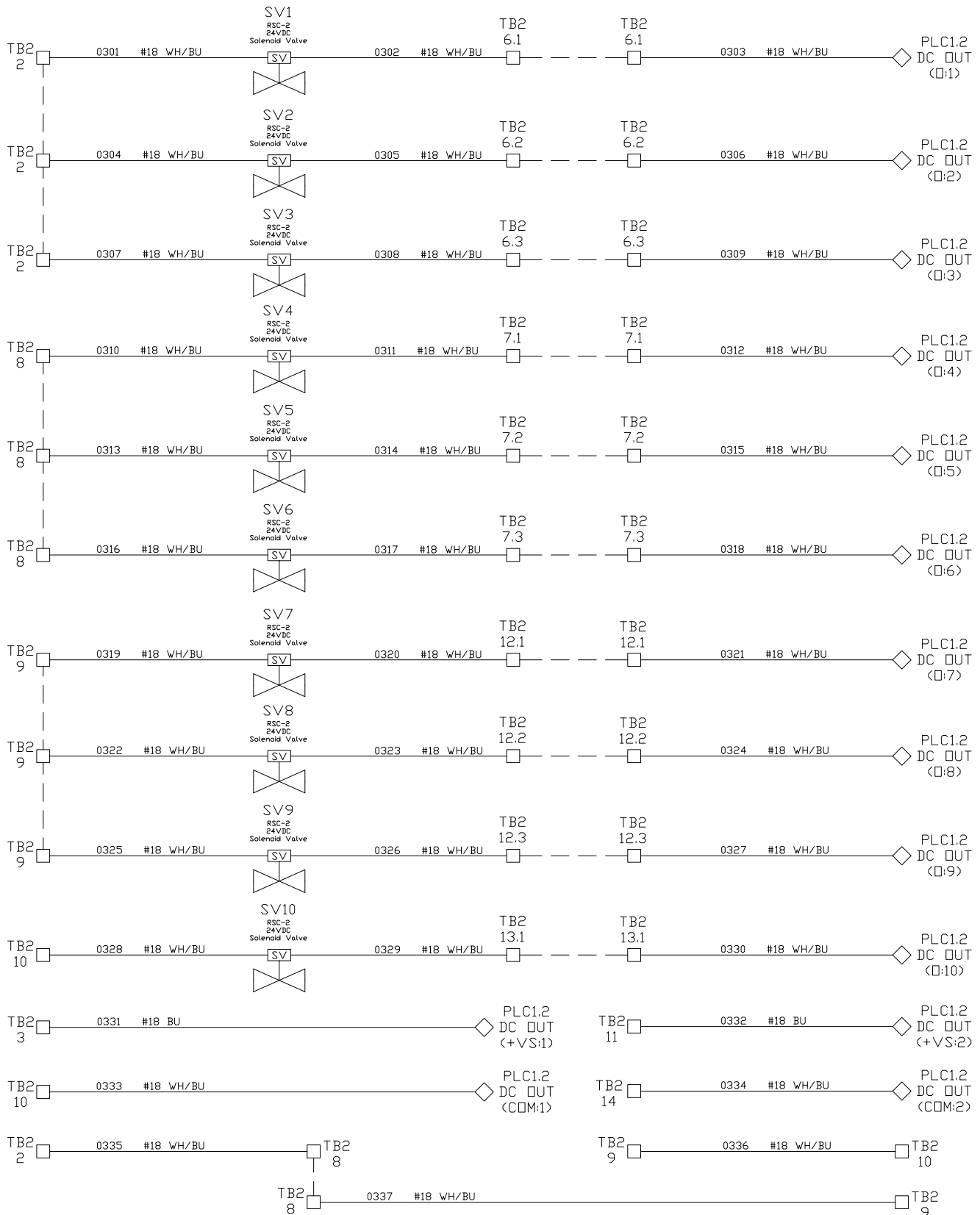

**Notes:** Cable #0334  
Change from TB2  
10 to TB2 14

**TITLE:** PLC Output Card

**Drawn By:** Kurt J. Foster

See "MIT Licence"

**Project Code:** PR-01

**REV:** 1.1

**Date:** May 7, 2023

SCHEMATIC IS PROVIDED AS IS, WITHOUT WARRANTY OF ANY KIND, EXPRESS OR IMPLIED, INCLUDING BUT NOT LIMITED TO THE WARRANTIES OF MERCHANTABILITY, FITNESS FOR A PARTICULAR PURPOSE AND NONINFRINGEMENT. IN NO EVENT SHALL THE AUTHORS OR COPYRIGHT HOLDERS BE LIABLE FOR ANY CLAIM, DAMAGES OR OTHER LIABILITY, WHETHER IN AN ACTION OF CONTRACT, TORT OR OTHERWISE, ARISING FROM, OUT OF OR IN CONNECTION WITH THE SCHEMATIC OR THE USE OR OTHER DEALINGS IN THE SCHEMATIC.



Sheet: 3

# E-004 PLC Relay Card

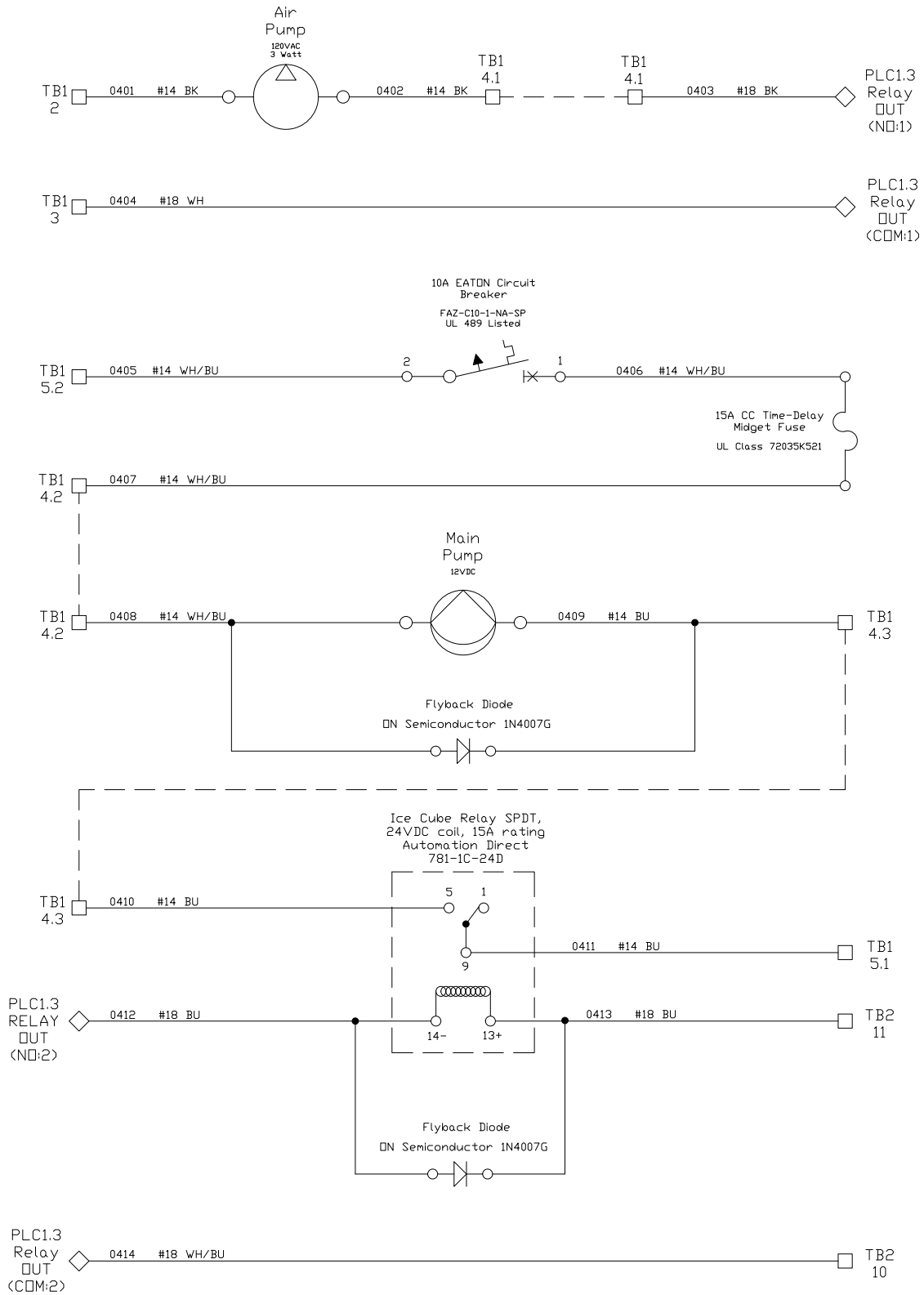

## Notes:

TITLE: PLC Relay, Air & Water Pump

Drawn By: Kurt J. Foster

See "MIT Licence"

Project Code: PR-01

REV: 1.0

Date: May 7, 2023

SCHEMATIC IS PROVIDED AS IS, WITHOUT WARRANTY OF ANY KIND, EXPRESS OR IMPLIED, INCLUDING BUT NOT LIMITED TO THE WARRANTIES OF MERCHANTABILITY, FITNESS FOR A PARTICULAR PURPOSE AND NONINFRINGEMENT. IN NO EVENT SHALL THE AUTHORS OR COPYRIGHT HOLDERS BE LIABLE FOR ANY CLAIM, DAMAGES OR OTHER LIABILITY, WHETHER IN AN ACTION OF CONTRACT, TORT OR OTHERWISE, ARISING FROM, OUT OF OR IN CONNECTION WITH THE SCHEMATIC OR THE USE OR OTHER DEALINGS IN THE SCHEMATIC.

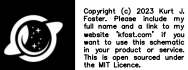

Sheet: 4



# E-006 pH Measure & Adjust Valves

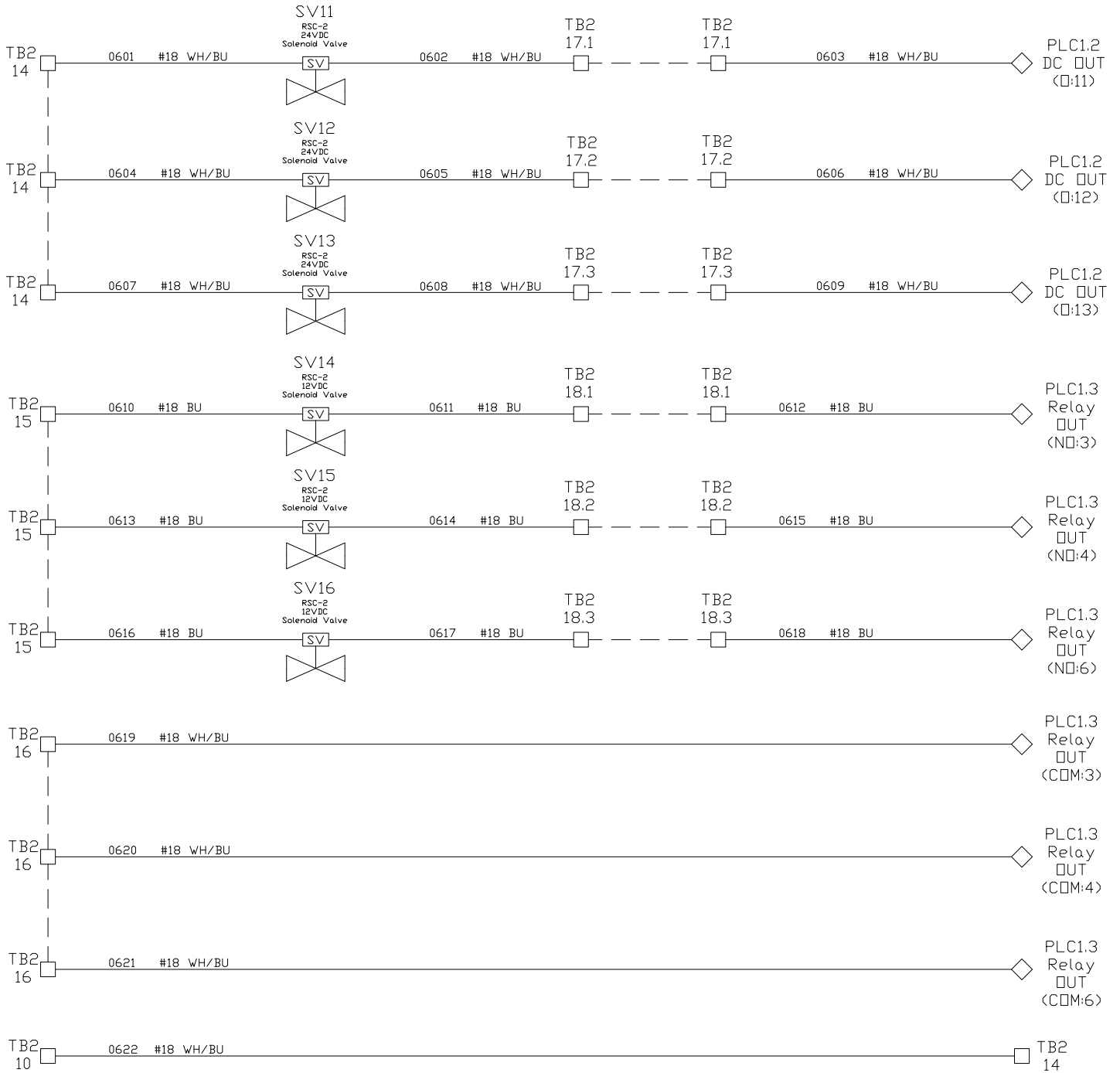

**Notes:**

**TITLE:** 24/12VDC Valves for pH

**Drawn By:** Kurt J. Foster

See "MIT Licence"

**Project Code:** PR-01

**REV:** 1.0

**Date:** May 7, 2023

SCHEMATIC IS PROVIDED AS IS, WITHOUT WARRANTY OF ANY KIND, EXPRESS OR IMPLIED, INCLUDING BUT NOT LIMITED TO THE WARRANTIES OF MERCHANTABILITY, FITNESS FOR A PARTICULAR PURPOSE AND NONINFRINGEMENT. IN NO EVENT SHALL THE AUTHORS OR COPYRIGHT HOLDERS BE LIABLE FOR ANY CLAIM, DAMAGES OR OTHER LIABILITY, WHETHER IN AN ACTION OF CONTRACT, TORT OR OTHERWISE, ARISING FROM, OUT OF OR IN CONNECTION WITH THE SCHEMATIC OR THE USE OR OTHER DEALINGS IN THE SCHEMATIC.



**Sheet:** 6